

Rating	12 VDC / 0.05A / 0.6W	Mounting Hole 	Circuit Diagram 
Insulation Resistance	DC 500V 100MQ 1 Min.		
Dielectric Strength	AC 1000V 1 Minute		
Operation Temperature	-20°C~+60°C		
LED Type	SMD LED(White)* 8		
CCT	5700K±20%		
Illuminance	12 Lux±10% at 80cm		
Luminous Flux	35 Lm±10%		
Protection of Dust and Water	IP66		

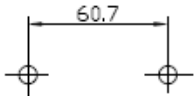

Material:  
 Cover: ABS, Chrome plating  
 Lens: PC Water Clear  
 Cable: Black/Red UL 1430,18AWG,150mm  
 Rohs compliant .

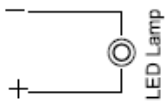
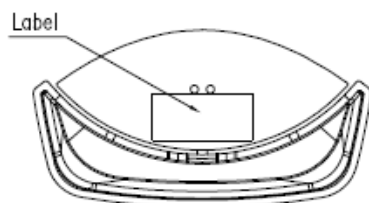
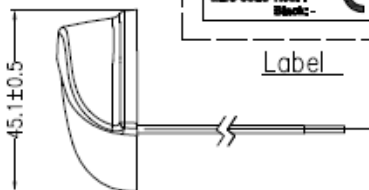
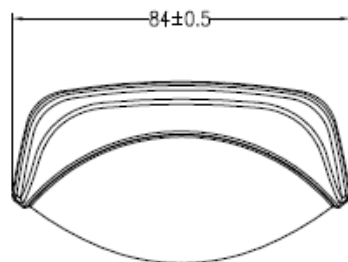
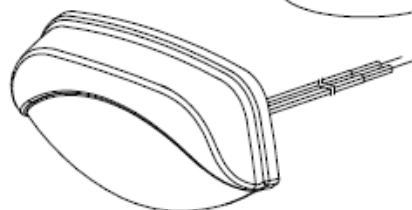
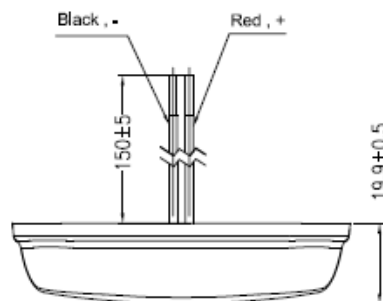
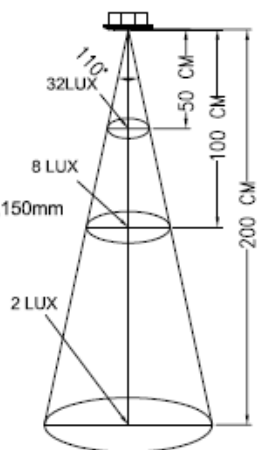

Date	Name	Description				No.
Drawn	Checked	Approved	SCI BOM No	Model Name	LED Courtesy Light	
劉嘉麗			Customer No	Model No.		Rev. X0
08/16/14			Unit	mm		