

INSTRUCTION MANUAL: A LAPCON SERIES PRODUCT SOFT DOWN STAY TYPE SDS-C301N

LAMP®

● Please follow these instructions carefully for proper use.

PAT. (Japan & many other countries)

HOW TO INSTALL AND POSITION THE MOUNTING PLATE

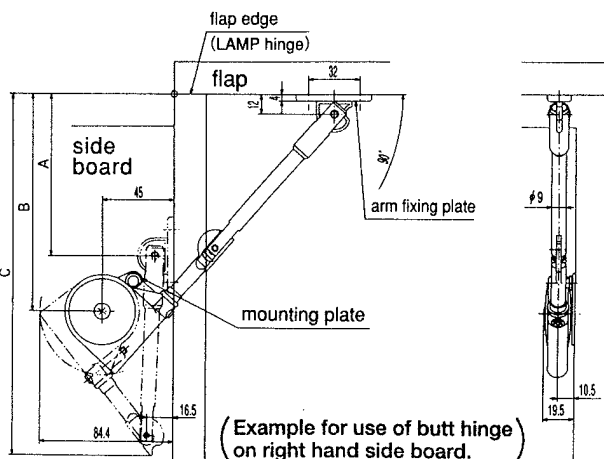

● PLATE POSITION FOR INSTALLATION

Depending on the type of the hinges used, the position of the mounting plate and arm fixing plate should be fixed as indicated below. In this case where LAMP hinge (220-26/19T) is used, the distance for A/B/C is measured from the flap edge.

	A	B	C
LAMP Hinge (220-26/19T)	108mm	143mm	232mm

(1 inch = 25.4mm)

When other types of hinges are used, please contact our sales staff.

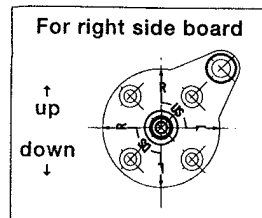

The installation direction of the mounting plate. (Type SDS-C301N follows the inscription of "US".)

For right side fixing, the arrow of "R" on the US side should point upward vertically. For left side fixing, the arrow of "L" on the US side should point upward vertically.

● HOW TO INSTALL

Install the mounting plate and arm fixing plate with the enclosed wood screws at the designated places.

- ① Insert the "key" of the cam of arm-tip into the key hole of the fixing plate. The main body must be placed at 90 degrees angle against the fixing plate.

- ② Turn the main body 90 degrees and insert the knurly axis of the mounting plate to the hole of the main body.
- ③ Fix the main body with bind screw attached.

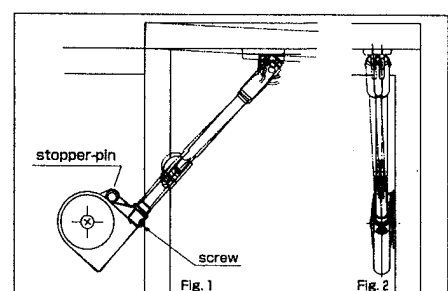
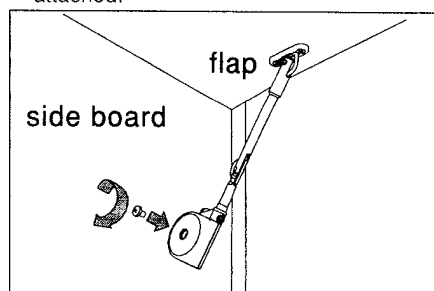
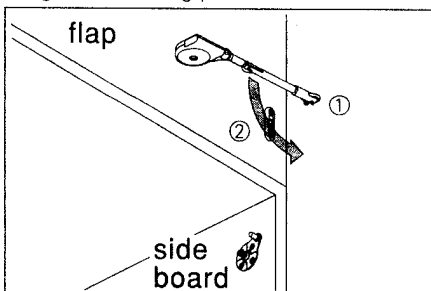

● ADJUSTMENT

At maximum door opening angle, make the adjustment of arm-fold in straight by adjustable screw of main body on stopper-pin.

THE DIMENSION OF THE FLAP

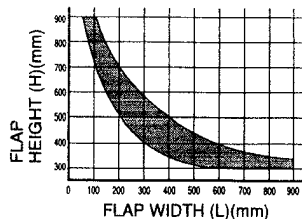
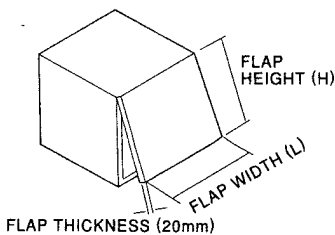

THE DIMENSION OF THE FLAP

SOFT DOWN STAY must be used taking the size of the flap into consideration. The graph indicates the usable range when using one SDS stay. When using two stays, the width of flap can be twice as large, if the height remains unchanged.

(Note) The graph shown to the left is in case of a general wooden flap of 20mm thick (specific gravity approx. 0.5)

- In case of lighter or heavier flap doors that do not fit within the above specified range, please contact our sales staff.

MATERIAL AND FINISH

Material: Plastic and steel Finish: Nickel plated (steel)

REMARKS

- To avoid serious damage and/or injury, do not attempt to disassemble the body of SDS stay.
- Please contact our sales staff when you use LAPCON series products under extremely high and/or low temperature.
- Dimension and specification can be changed with or without notice.
- This product is developed as a flap stay. Do not use it for other purpose.
- Do not attempt to close the flap with extra force.