



AUTO TAB CONTROL (ATC) OWNER'S MANUAL & INSTALLATION INSTRUCTIONS



IMPORTANT: This manual contains critical information directly affecting the safe and efficient operation of your boat. Please read thoroughly before operating the Auto Tab Control system.

**SAVE AND KEEP WITH
BOAT OWNER'S INFORMATION**

Congratulations!

You are the owner of the most sophisticated Trim Tab control system in the world. Nothing will create a more efficiently trimmed boat than the ATC. It constantly monitors your boat's position and uses your trim tabs to maintain your optimal cruising attitude.

SECTION 1

A BASIC PRODUCT UNDERSTANDING

The Bennett ATC system is composed of three main components:

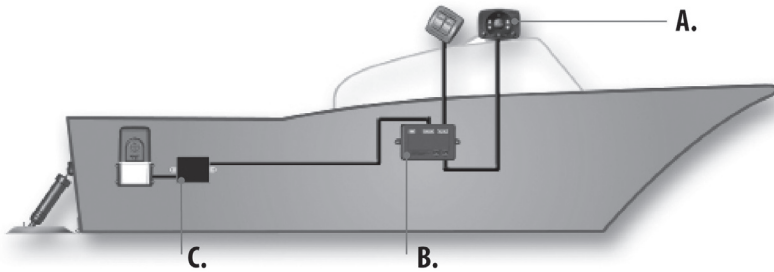

A: ATC Keypad — The ATC Keypad enables you to turn the ATC system ON and OFF, and set the Zero Point for your boat's best running attitude. The up and down arrows will flash showing trim tab adjustments.



B: ATC Control Unit — The ATC Control Unit is a sophisticated processor and attitude sensor. It analyzes and calculates attitude readings. It "learns" and stores the characteristics of your boat in its memory and uses this information for precise trim tab corrections. **Important: The ATC Control Unit must be mounted correctly or the ATC system will not function as it should.**



C: Relay Module — The Relay Module Links the Hydraulic Power Unit to the Auto Tab Control system.

SECTION 2

BEFORE INSTALLING THE AUTO TAB CONTROL, YOU MUST CHECK THE TRIM TAB SYSTEM INSTALLATION

The ATC system interfaces with the boat's trim tab system, and automatically operates the trim tab Hydraulic Power Unit (HPU). Therefore before you install and operate the ATC system it is critical you confirm that the HPU wiring and hydraulic tubing is connected EXACTLY as described in items 1 and 2 below.

1. Hydraulic Tubing:

- Tubing from the port actuator must be connected to the fitting marked "P" (front left) on the HPU.
- Tubing from the starboard actuator must be connected to the fitting marked "S" (front right) on the HPU.

THE TUBING MUST NOT BE REVERSED

2. Helm Control Wiring:

Verify that the four-color wire harness leading to the back of the trim tab helm control is wired as follows.

For Single Lever and Rocker Switch Controls

Notice the indented letters on the back of the control, make sure connections are as follows:

- Red wire connects to "R"
- Green wire connects to "G"
- Blue wire connects to "B"
- Yellow wire connects to "Y"

For Racing Type Control

Facing the control, with the word BOW at the top, turn the control over to the right (or left) and inspect the control to ensure the wiring is connected as follows:

- The blue wire is connected to the top two terminals
- The red wire is connected to the two left terminals
- The yellow wire is connected to the two bottom terminals
- The green wire is connected to the two right terminals

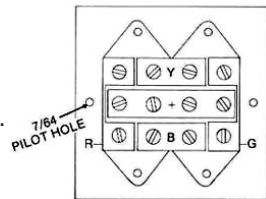

Rocker Switch Control

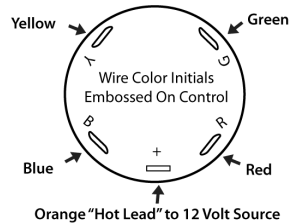

Single Lever Control

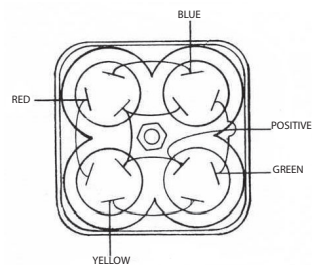

Racing Type Control

THE WIRING CONNECTIONS MUST NOT BE REVERSED

For Boat Leveler Insta-Trim Systems

The Auto Tab Control installation instructions are based on Bennett Trim Tab wire colors. If you are installing the Auto Tab Control on a Boat Leveler system, the wire color conversion is as follows:

- Bennett RED wire = Insta-Trim GREEN wire
- Bennett GREEN wire = Insta-Trim WHITE wire
- Bennett Blue wire = Insta-Trim RED wire
- Bennett YELLOW wire = Insta-Trim YELLOW wire

FAILURE TO COMPLY WITH ITEMS 1 AND 2 ON PAGE THREE WILL CAUSE THE AUTO TAB CONTROL TO FUNCTION IMPROPERLY

If you have any questions regarding items 1 and 2 contact Bennett Marine by e-mail at info@BennettTrimTabs.com or call Bennett Marine Client Services at (954) 427-1400 (8:00 a.m. - 5:00 p.m. Eastern time, Monday through Friday).

SECTION 3 USING THE AUTO TAB CONTROL FOR THE FIRST TIME

How to Set the Zero Point. IMPORTANT NOTE: The ATC won't turn on or function correctly until you've set the "Zero Point." (If the Zero Point has not been set, the **blue Set Zero** light will flash.)

Setting the Zero Point. After installing the system, take your boat for a test run. When underway, use the manual trim tab control to get your boat running at the best running attitude. Press and hold **both** "Set Zero" buttons (Sun and Moon Buttons) on the ATC Keypad (about 4 seconds) until the blue LED flashes rapidly. After the LED is flashing, release the buttons. Your boat's attitude is now set in the memory.



NOTE: The system automatically turns off as soon as you've set the Zero Point and released the buttons.

TIP: If you cruise within a wide range of running speeds (Example: 20 to 40 mph) you should set the Zero Point within the lower half of the running range.

Turning the ATC on. Once you've set the Zero Point you can now press the ON/OFF button for 2-3 seconds to turn your ATC on. It will now take control of your trim tabs.

ATC Memory. Once the Zero Point is set, the ATC will retain this attitude in memory permanently, or until it is reset. As long as the tabs are of correct size and the speed adequate, the ATC will recreate the programmed attitude regardless of changes in speed, weight distribution, sea conditions, and other variables that affect the boat's attitude. If you want to reset the Zero Point, just follow the same procedure as above.

Adjusting LED Intensity. You can adjust the brightness of the ATC LEDs using the Sun and Moon buttons for different times of day or night. These buttons are also used for setting the Zero Point.

HELPFUL HINT: Most boats "break over" (get on plane) at a particular speed. This speed is determined by weight distribution, water conditions, etc. Every boat has one particular attitude where it runs most efficiently. When you reach the best running attitude for your boat, enter it as the Zero Point.



Optimal Running Attitude. A good way to reveal your boat's optimum attitude is to conduct a test by running lightly loaded at full speed in flat water. (This should be done in an open, no traffic area.) You will confirm your boat's ideal attitude by observing the bow in relation to the horizon, reduced bow spray, and diminished wake.

SECTION 4

ACTIVATING AND DEACTIVATING THE AUTO TAB CONTROL

The ATC system is activated by pressing the ON/OFF button for 2-3 seconds. When the button is released, the red ON/OFF LED lights up indicating the unit is operating. Once activated, the ATC continuously analyzes and calculates the attitude of your boat and directs messages to operate the trim tabs.

The ATC continues to make corrections as necessary until deactivated.

The yellow LED “arrows” on the Keypad flash, indicating direction of trim tab movement. Example: When the bottom direction arrow marked PORT TAB flashes, the port trim tab is deflecting downward. Conversely, when the top direction arrow flashes, the port trim tab is retracting. The same is true for the starboard trim tab direction arrows.

When one or both of the ATC Keypad’s trim tab direction arrows remains in the on mode, the ATC has determined one or more of the trim tabs has reached a limit. Unit resumes operation once the boat’s attitude changes.

ONCE ACTIVATED, THE ATC SYSTEM ADJUSTS THE TRIM TABS AUTOMATICALLY UNTIL YOU DEACTIVATE IT BY EITHER:

1. PRESSING THE ATC KEYPAD’S ON/OFF BUTTON (Recommended method)
2. PRESSING ANY POSITION OF THE TRIM TAB HELM CONTROL **OR**
3. CUTTING THE POWER SOURCE TO THE ATC SYSTEM

SECTION 5

SAFETY PRECAUTIONS AND INFORMATION

- For bow high attitude, the ATC system should be deactivated and the trim tabs manually placed in the full-up position when running in a following sea.
- For bow high attitude, the ATC system should be deactivated and the trim tabs manually placed in the full-up position when running an inlet.
- The boat must be properly trimmed when the ATC Zero Point is set.
- The ATC system is programmed not to activate during sharp turns.
- Speed, load, and trim tab size may be such that the ATC and trim tabs are unable to trim the boat at certain speeds.
- Occasionally check for loose or corroded wiring connections on the ATC system and trim tab system and lubricate when necessary.
- To avoid component damage, when power is “ON” do not connect or disconnect any plugs connected into the Control Unit or any other component of the system.
- Take immediate action to correct any malfunction or failure of your trim tabs.
- Improper use of the ATC system or trim tabs can cause an accident or injury.

BE PRUDENT — IF IT APPEARS THE ATC SYSTEM IS CAUSING YOUR BOAT TO REACT IN AN UNDESIRABLE MANNER, STOP THE BOAT – THEN INVESTIGATE THE PROBLEM.

Trim tabs and the ATC system have a significant effect on the operation and versatility of your boat, and nobody knows your boat better than you. The best learning method is to spend time getting familiar with your boat's reaction to the trim tabs and ATC system. Always operate your boat with safety first in mind.

SECTION 6 TROUBLESHOOTING THE SYSTEM

1. Activating the ATC system causes the boat to list (lean).

- Trim tab tubing or wiring may be crossed. See the “Before Installing the Auto Tab Control” section of this manual.
- ATC system Zero Point may be incorrectly set.

2. The boat slows or is hard to steer.

It is likely that the boat is in an overtrimmed condition. The Zero Point should be reset with the bow slightly higher.

3. All LEDs on the ATC Keypad flash simultaneously.

Control Unit signal is interrupted. Check Keypad cable for breaks and check firmness of connection into ATC Control Unit.

4. “SET ZERO” light flashes.

No Zero Point has been set. Refer to Section 3 of this manual.

5. ATC system shuts off by itself.

- Control Unit may be receiving low voltage (less than 7 volts).
- If the boat is in a severe list (greater than 26 degrees), the trim tabs will fully retract and the ATC system will automatically turn off.

6. The ATC attempts to make a particular attitude correction several times and is unable to affect the boat's attitude.

The boat may be going too slow or the trim tabs may be undersized.

NOTE: The ATC attempts to make a particular attitude correction several times. It forces the trim tabs to remain in a particular corrective position until the attitude changes. If it appears the trim tabs frequently cannot correct an out-of-trim position, the trim tabs may be undersized or boat speed too low.

AUTO TAB CONTROL (ATC) INSTALLATION INSTRUCTIONS

IMPORTANT: Plan how you will lay out the system.
Consider the wire runs from the Keypad to the Control Unit.



**Make sure battery power
is disconnected!**

For Non-Electronic Bennett Trim Tab Control Systems
(Rocker Switch Control, Single Lever Control and Racing Type Control)
(Refer to Diagram on Page 12)

Step 1: Mounting the Control Unit

NOTE: The Control Unit **MUST** be mounted properly for the system to work correctly. Mount the Control Unit with the following guidelines:

- **Location:** Mount within 6 feet of the ATC Keypad. (ATC Keypad Cable is 6' long.)
- **Minimum Vibration:** Mount on a surface that is free of excessive vibration.
- **Dry Environment:** Mount the Control Unit in a dry location.
- **Level Surface:** Mount the Control Unit on a relatively level surface. It is not necessary to mount the Control Unit on a perfectly level surface, as setting the Zero Point will account for some off-level mounting. However, do not mount the Control Unit at an angle, upside down or vertically.
- **Pointing Forward:** Align the arrow on the top of the Control Unit parallel with the direction of the centerline (Keel) of the boat.

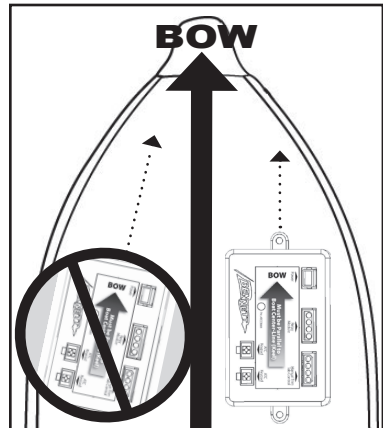

Step 2: Mounting the ATC Keypad

- Cut out the template from the last page of this manual.
- Tape the template to the dash where you intend to mount the Keypad. (Make sure it is within 6 feet of the Control Unit.) Check behind panel for wires or obstruction.
- Drill a 3/4" hole for the ATC Keypad cable and two 3/16th-inch holes for the mounting screws.
- Connect the ATC Keypad Cable to the Keypad. Apply a thin bead of silicone sealant around the perimeter of the Keypad back. Use the two enclosed thumb nuts to secure the Keypad to the dash.
- Plug the ATC Keypad Cable into the Control Unit marked "ATC Keypad." You can use either of the two ATC Keypad connectors. The extra connector is for an additional Keypad for an upper station.

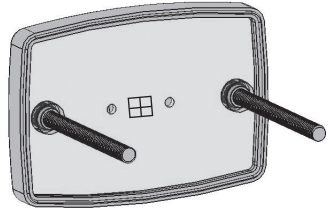

Step 3: Connecting the ATC Power Pigtail

- Connect the orange wire to a 12 volt positive (+) power source that is switched "on" with the ignition.
- Connect the black wire to ground (-).
- Do not plug the ATC Power Pigtail into the Control Unit yet.

Step 4: Connecting the ATC Control Unit to the Trim Tab Manual Control

- Remove your existing Manual Control from the dash.
- Disconnect the **Red, Green, Yellow and Blue** wires from the back of the Manual Control.
- **Do not disconnect the Orange power wire.** However, replace the Orange wire in-line fuse and use the enclosed **1.5 amp fuse.**
- Trim the wires of the enclosed **6-foot ATC 4-Color Wire Harness** to length and strip the wire ends.
- Crimp the enclosed ring terminals to the ATC 4-color Wire Harness.
- Connect the wires to the back of the control — Red wire to "R," Green wire to "G," Yellow wire to "Y," and Blue wire to "B."
- Reinstall the Manual Control.
- Plug the Wire Harness into the Control Unit connection marked "**Manual Control.**"

Step 5: Connecting the Trim Tab Wire Harness to the ATC Control Unit

- Cut the terminals off the ends of the existing 4-color Trim Tab Wire Harness.
- Strip approximately 3/16ths of an inch on each wire.
- Crimp the butt splices on the Pigtail for Wire Harness (PT109) onto the Trim Tab Wire Harness, matching color to color.
- Plug the Pigtail for Wire Harness (PT109) into the Control Unit connection marked “Relay Module.”



Step 6: Mounting the Relay Module

- The Relay Module is best located in a dry location close to the Hydraulic Power Unit.
- Disconnect your Trim Tab Wire Harness from your Hydraulic Power Unit.
- Plug the Hydraulic Power Unit Harness into the Relay Module Pigtail Connector.
- Plug the Trim Tab Wire Harness (*already attached to the Control Unit in Step 5 above*) into the remaining Pigtail Connector coming out of the Relay Module.
- Attach the black wire of the Relay Module Power Connectors to ground (or to the ground stud on the back of the HPU motor) and the orange wire with the in-line 20 amp fuse to a 12 volt positive source.



Step 7: System Check

- Plug the ATC Power Pigtail connector into the Control Unit marked “Power Connection.”
- Turn the boat power back on.
- Test the trim tabs using the Manual Control. Make sure the trim tabs are working correctly. If not, check the connections on the Control Unit, the Manual Control and the Relay Module. (Remember, the right hand buttons on the Rocker Control and Racing Control operate the port trim tab and vice versa.)
- The ON/OFF ATC Keypad button will not activate the ATC system until the initial Zero Point is set. If you turn on the ATC at this point, the blue Zero Set LED light will flash. Refer to section 3, “Using the Auto Tab Control for the first time.”

Installation Instructions for Electronic Indicator Control (EIC5000) Systems

IMPORTANT: If you did not purchase the Auto Tab Control set designed for the Electronic Indicator Control (EIC) you will have to contact Bennett Marine for a Wire Harness to run from the EIC Module to the ATC Control Unit.

(Refer to Diagram on Page 13)

Follow steps 1, 2 and 3 from the Non-Electronic Bennett Trim Tab Control Systems Instructions.

Connecting the ATC Control Unit to the EIC Relay Module

- The EIC Relay Module has a special connector built in for the Auto Tab Control. It is the shorter of the two Wire Pigtails coming out of the module.
- Connect the 25-foot Wire Harness (WH100025) to this shorter Wire Pigtail.
- Run the Wire Harness to the Control Unit at the helm. Trim the Wire Harness to the desired length and strip the wire ends. Strip approximately 3/16ths of an inch on each wire.
- Crimp the butt splices on the Pigtail for Wire Harness (PT109) onto the Wire Harness, matching color to color.
- Plug the Pigtail for Wire Harness (PT109) into the Control Unit connection marked “Relay Module.”

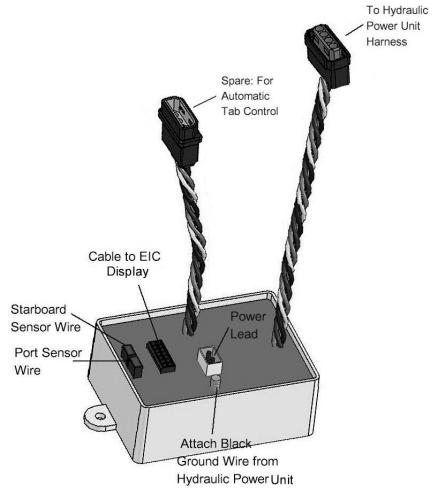

System Check

- Plug the ATC Power Pigtail connector into the Control Unit marked “Power Connection.”
- Turn the boat power back on.
- Test the trim tabs using the control. Make sure your trim tabs are working correctly. If not, check the connections on the Control Unit, the EIC Control, and the Relay Module.
- The ON/OFF ATC Keypad button will not activate the ATC system until the initial Zero Point is set. If you turn on the ATC at this point, the blue Zero Set LED light will flash. Refer to section 3, “Using your Auto Tab Control for the first time.”

System Schematic and Parts List for Non-Electronic Trim Tab Controls

Description	Part #	Optional Upper Station	
Description	Part #	Description	Part #
1 ATC Keypad	AC3250	9 ATC Keypad	AC3250
2 ATC 6' Keypad Cable	AC32506	10 ATC 22' Keypad Cable	AC325022
3 ATC Control Unit	AC3400	11 ATC Hardware Bridge	AC3225
4 ATC Power Pigtail	AC3121	<i>(not shown)</i>	
5 Pigtail for Wire Harness	PT109		
6 ATC 4-Color 6' Wire Harness	WH3006		
7 Relay Module - 12 or 24 Volt	RM12 (or RM24)		
8 ATC Hardware Bag	AC3200		
<i>(not shown)</i>			

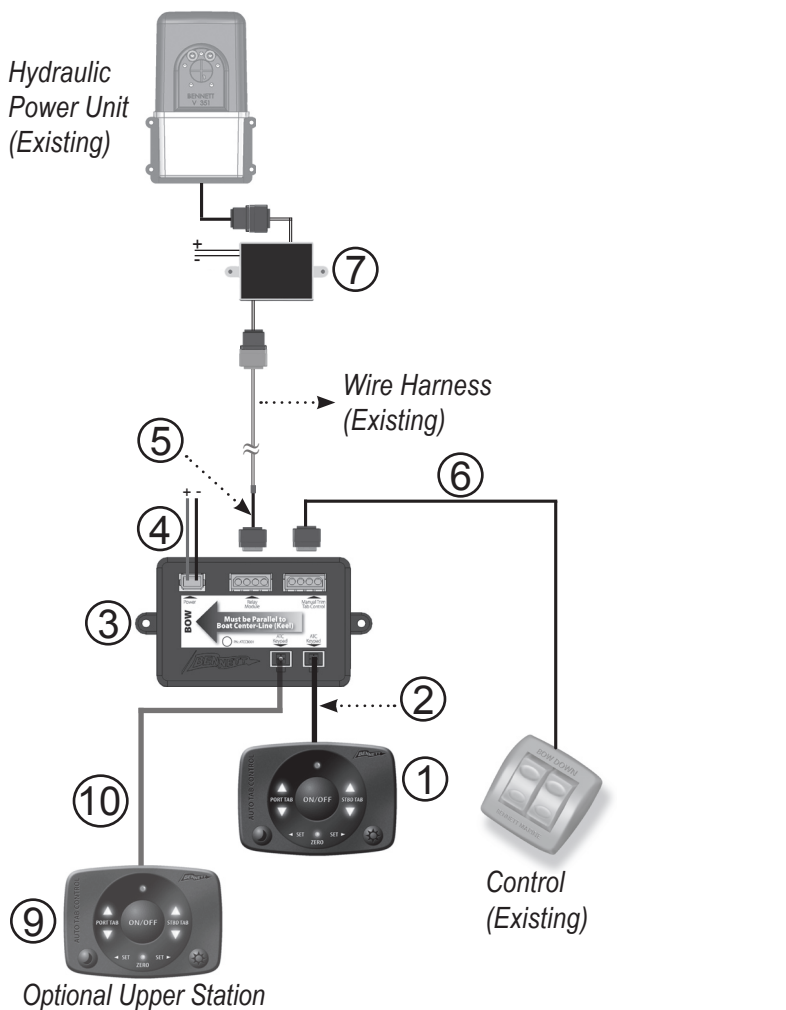

System Schematic and Parts List for Bennett Electronic Indicator Control System

Description	Part #		
1 ATC Keypad	AC3250		
2 ATC 6' Keypad Cable	AC32506		
3 ATC Control Unit	AC3400		
4 ATC Power Pigtail	AC3121		
5 Pigtail for Wire Harness	PT109		
6 25' Wire Harness	WH100025		
7 ATC Hardware Bag (not shown)	AC3200		
		Optional Upper Station	
		Description	Part #
		8 ATC Keypad	AC3250
		9 ATC 22' Keypad Cable	AC325022
		10 ATC Hardware Bridge (not shown)	AC3225

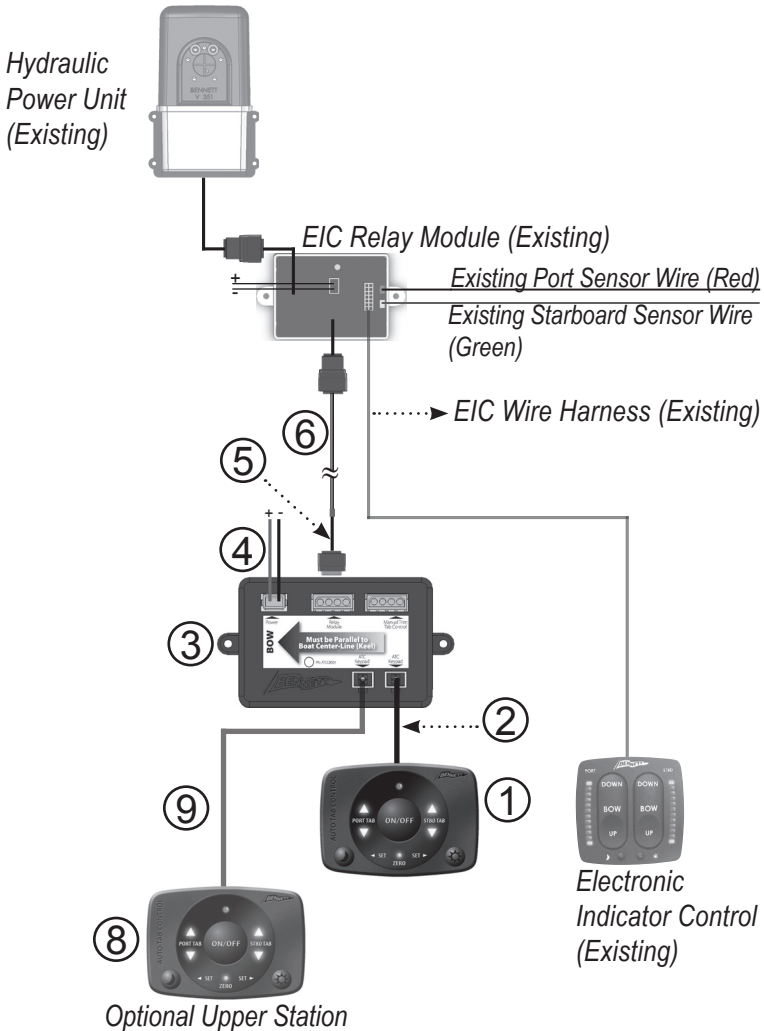

If you have any questions regarding the installation of the
Bennett Auto Tab Control, please contact us at
Bennett Marine, Inc
550 Jim Moran Blvd.
Deerfield Beach, FL 33442

Phone: 954-427-1400
Email: info@BennettTrimTabs.com
Web: www.BennettTrimTabs.com

ATC KEYPAD MOUNTING TEMPLATE

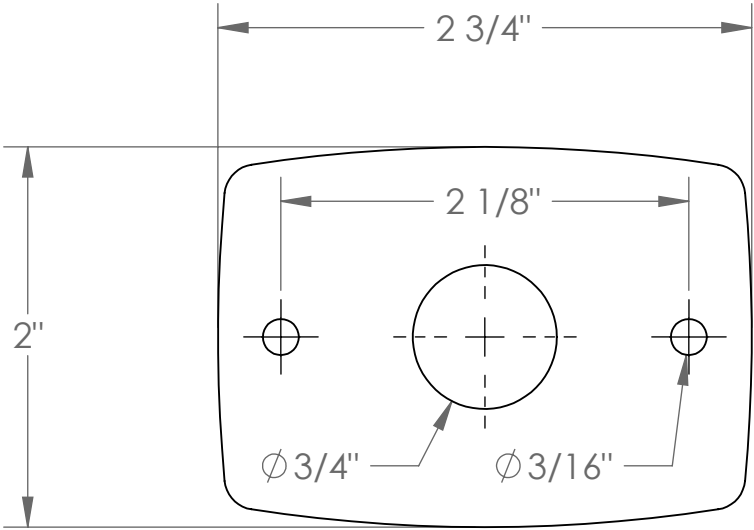

ATC20

P-ATC-X